



# ***Operator's Manual***

***GS-3384***  
***GS-3390***  
***GS-4390***  
***GS-5390***

AUS  
Australia

with  
Maintenance  
Information

Fifth Edition  
Third Printing  
Part No. 227509

---

## Important

Read, understand and obey these safety rules and operating instructions before operating this machine. Only trained and authorized personnel shall be permitted to operate this machine. This manual should be considered a permanent part of your machine and should remain with the machine at all times. If you have any questions, please call Genie.

---

## Contents

|   | Page |
|---|------|
| Introduction .....                              | 1    |
| Symbols and Hazard Pictorials Definitions ..... | 3    |
| General Safety .....                            | 5    |
| Personal Safety .....                           | 7    |
| Work Area Safety .....                          | 8    |
| Legend .....                                    | 15   |
| Controls .....                                  | 16   |
| Inspections .....                               | 21   |
| Operating Instructions .....                    | 34   |
| Transport and Lifting Instructions .....        | 40   |
| Maintenance .....                               | 43   |
| Specifications .....                            | 46   |

---

## Contact us:

Internet: <http://www.genielift.com>  
 e-mail: [awp.techpub@terex.com](mailto:awp.techpub@terex.com)

---

Copyright © 2002 by Terex

Fifth Edition: Third Printing, November 2015

"Genie" is a registered trademark of Terex South Dakota in the U.S.A. and many other countries. "GS" is a trademark of Terex South Dakota.

These machines comply with AS 1418.10

 Printed on recycled paper

Printed in U.S.A.



## Introduction

### Owners, Users and Operators:

Genie appreciates your choice of our machine for your application. Our number one priority is user safety, which is best achieved by our joint efforts. We feel that you make a major contribution to safety if you, as the equipment users and operators:

- 1 **Comply** with employer, job site and governmental rules.
- 2 **Read, understand and follow** the instructions in this and other manuals supplied with this machine.
- 3 **Use good safe work practices** in a common sense way.
- 4 **Only have trained/certified operators**, directed by informed and knowledgeable supervision, running the machine.

If there is anything in this manual that is not clear or which you believe should be added, please contact us.

Internet: [www.genielift.com](http://www.genielift.com)

E-mail: [techpub@genieind.com](mailto:techpub@genieind.com)



---

### Danger

Failure to obey the instructions and safety rules in this manual will result in death or serious injury.

---

### Do Not Operate Unless:

- You learn and practice the principles of safe machine operation contained in this operator's manual.

#### 1 Avoid hazardous situations.

**Know and understand the safety rules before going on to the next section.**

- 2 Always perform a pre-operation inspection.
- 3 Always perform function tests prior to use.
- 4 Inspect the workplace.
- 5 Only use the machine as it was intended.

- You read, understand and obey the manufacturer's instructions and safety rules—safety and operator's manuals and machine decals.
- You read, understand and obey employer's safety rules and worksite regulations.
- You read, understand and obey all applicable governmental regulations.
- You are properly trained to safely operate the machine.

## Introduction

### Hazard Classification

Genie uses symbols, color coding and signal words to identify the following:



Safety alert symbol—used to alert you to potential personal injury hazards. Obey all safety messages that follow this symbol to avoid possible injury or death.

#### **▲ DANGER**

Red

Indicates a hazardous situation which, if not avoided, will result in death or serious injury.

#### **▲ WARNING**

Orange

Indicates a hazardous situation which, if not avoided, could result in death or serious injury.

#### **▲ CAUTION**

Yellow

Indicates a hazardous situation which, if not avoided, could result in minor or moderate injury.

#### **NOTICE**

Blue

Indicates a hazardous situation which, if not avoided, could result in property damage.













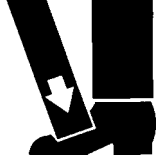

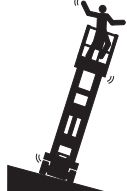

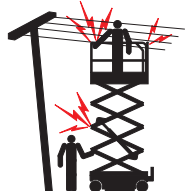

### Intended Use

This machine is intended to be used only to lift personnel, along with their tools and materials to an aerial work site.

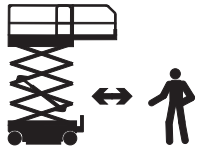

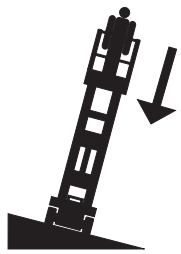

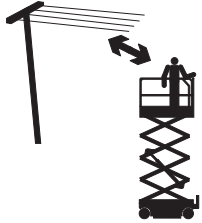







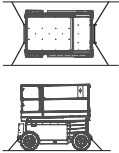

### Safety Sign Maintenance

Replace any missing or damaged safety signs. Keep operator safety in mind at all times. Use mild soap and water to clean safety signs. Do not use solvent-based cleaners because they may damage the safety sign material.

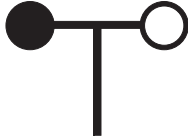
## Symbol and Hazard Pictorials Definitions

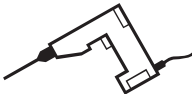
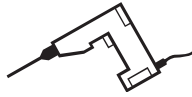
|   |   |   |   |  |
|---|---|---|---|--|
| <br>Read the operator's manual | <br>Read the service manual                                    | <br>Crush hazard                         | <br>Crush hazard  | <br>Collision hazard  |
| <br>Tip-over hazard            | <br>Tip-over hazard  | <br>Tip-over hazard                      | <br>Tip-over hazard  | <br>Electrocution hazard                                    |
| <br>Electrocution hazard      | <br>Explosion hazard  | <br>Fire hazard                         | <br>Burn hazard  | <br>Skin injection hazard                                  |
| <br>Engage safety arm        | <br>Keep away from moving parts                              | <br>Keep clear of outriggers and tires | <br>Move machine to level ground                                  | <br>Close chassis tray                                    |
| <br>Lower the platform       | <br>Do not set up where it cannot be leveled with outriggers | <br>Maintain required clearance        | <br>Only trained maintenance personnel should access compartments | <br>Use a piece of cardboard or paper to search for leaks |

## Symbol and Hazard Pictorials Definitions

|  |  |  |  |   |
|--|--|--|--|---|
|  <p>Chock the wheels</p>                      |  <p>Release brakes</p>                            |  <p>Tiedown</p>           |  <p>Lanyard attachment point</p> |  <p>No smoking</p>     |
|  <p>Wheel load</p>                            |  <p>Transport diagram</p>                         |  <p>Side force</p>        |  <p>Wind speed</p>               |  <p>Outrigger load</p> |
|  <p>Voltage rating for power to platform</p> |  <p>Pressure rating for air line to platform</p> |  <p>Maximum capacity</p> |  <p>Crushing hazard</p>        |   |
|  <p>Hold rail while lowering</p>            |  |  |  |   |

# General Safety

52494

**CAUTION**

Crushing Hazard  
Falling guard rails could cause injury.

Maintain firm grasp on platform rails when pulling snap pins. Do not allow platform guard rails to fall.

44736

**DANGER**

**Tip-over Hazard**  
If tilt-alarm sounds, unit is on a severe slope. Death or serious injury could occur.

- 1 Lower the platform.
- 2 Move the machine to level surface.

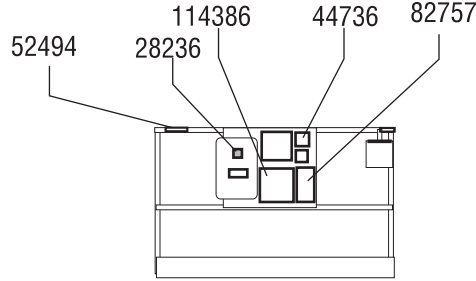

44255

**DANGER**

**Crushing Hazard**  
Contact with moving parts will result in death or serious injury.

Keep away from moving parts.

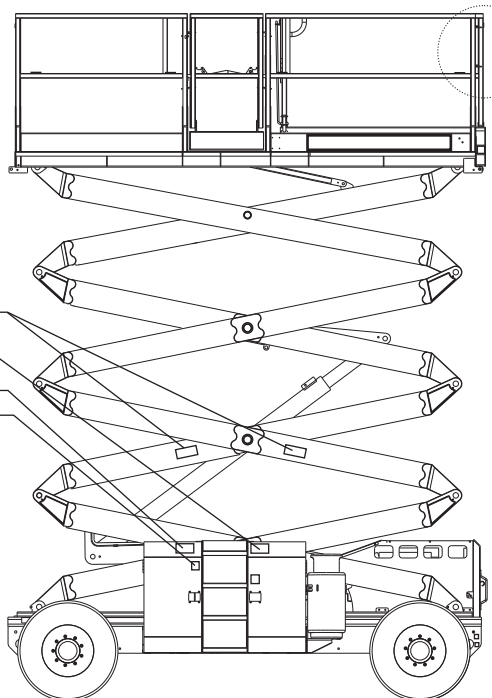

82561

**DANGER**

**Crushing Hazard**  
Death or serious injury can result from contact with moving scissor arms.

Engage safety arm before performing maintenance or repair.

See service manual.

44255

114385

82561

114258

82757

**DANGER**

**Failure to read, understand and obey the safety rules and operating instructions in the operator's manual will result in death or serious injury.**

**Tip-over Hazards**  
Do not lower outriggers unless machine is on a firm surface. Avoid drop-offs, holes, and other possible hazards. Do not set machine up where it cannot be leveled using only the outriggers.

**Do not raise platform unless all four outriggers are properly lowered, footpads are in firm contact with ground and machine is level.**  
Do not adjust outriggers while platform is raised.  
Do not drive while outriggers are lowered.

**Operating Instructions**  
Position machine below desired work area. Make sure the engine is running. Push and hold auto level button. Activate up/down rocker switch in down direction to extend outriggers and level machine. A beep will sound when machine is level. When indicator light on lift function enable button is red, lift and drive functions are disabled.

**Light turns green when outriggers are in firm contact with ground. Drive function is disabled while outriggers are down.**  
**To control individual outriggers**  
Push and hold one or more individual outrigger buttons.  
Activate up/down rocker switch in desired direction to level machine. When setting machine up on a slope without using auto level function, the laser and outriggers must be lowered first.

114385

**DANGER**

**Electrocution Hazard**  
Death or injury can result from contacting electric power lines. Always contact the electric power line owner. The electric power shall be disconnected or the power lines moved or insulated before machine operations begin.

| Line voltage    | Required clearance |
|-----------------|--------------------|
| 0 to 50KV       | 10 ft. 3.05 m.     |
| 50KV to 200KV   | 15 ft. 4.60 m.     |
| 200KV to 350KV  | 20 ft. 6.10 m.     |
| 350KV to 500KV  | 25 ft. 7.62 m.     |
| 500KV to 750KV  | 35 ft. 10.67 m.    |
| 750KV to 1000KV | 45 ft. 13.72 m.    |

114386

**DANGER**

**Failure to read, understand and obey the operator's manual and the following safety rules will result in death or serious injury.**

**Improper Use Hazards**  
The operator is responsible for safe machine operation. This includes:  
1. Avoid hazardous situations.  
2. Always perform pre-operation inspection.  
3. Always perform function tests prior to use.  
4. Inspect work area.  
5. Only use the machine as it was intended.

**Do not operate unless:**  
- You've read, understood and obeyed manufacturer's instructions and safety manuals and decals.  
- employer's safety rules apply.  
- applicable governmental regulations apply.  
- you are properly trained to safely operate this machine.

**Electrocution Hazards**  
This machine is not electrically insulated and will not provide protection from contact with or proximity to electrical current.

**Tip-over Hazards**  
Do not exceed rated load capacity. Do not raise platform unless machine is on a firm surface. Avoid drop-offs, holes and unstable or slippery surfaces. Do not drive machine on a slope that exceeds the maximum slope or side slope rating for the machine.

**Models without outriggers:**  
Do not raise platform unless machine is on a level surface.  
Models with outriggers:  
Do not raise platform unless machine is level.  
Do not raise platform when wind speeds may exceed 20 mph (17.7 m.p.h.). Do not operate machine in strong or gusty winds. Do not increase surface area of platform or load. Increasing area exposed to wind will decrease machine stability. Do not drive the machine on or near uneven terrain, unstable surfaces or other hazardous conditions with the platform raised.

**Do not push off or pull toward any object outside of the platform.**  
Do not place or attach overhanging loads to any part of this machine.

**Use extreme care and slow speeds while driving this machine in elevated position across uneven terrain, debris, unstable or slippery surfaces and near holes and drop-offs.**  
Do not alter or disable machine components that in any way affect safety and stability.  
Do not place ladders or scaffolds in platform or against any part of this machine.

**Explosion Hazards**  
Do not start engine if you smell or detect liquid petroleum gas (LPG), gasoline, diesel fuel or other explosive substances.  
Do not refuel the machine with the engine running.

**Do not use machine on a moving or mobile surface or vehicle.**  
Be sure all tires are in good condition, cattle nuts are properly tightened and coiler pins are properly installed.

**Fall Hazards**  
Do not sit, stand or climb on the platform guard rails. Maintain a firm footing on the platform floor at all times. Do not climb down from the platform when raised. Attach platform entry chain and close entry gate before operating.

**Crushing Hazards**  
Keep hands and limbs out of scissors. Use common sense and planning when operating machine with controller from ground. Maintain safe distances between operator, machine and fixed objects.

**Collision Hazards**  
Be aware of limited sight distance and blind spots when driving or operating. Check work area for overhead, obstructions or other possible hazards.

**Damaged Machine Hazards**  
Be aware of crushing hazard when grasping platform guard rail. Observe and use color-coded direction arrows on the platform controls for drive and steer functions.

**Be sure all maintenance has been performed as specified in the appropriate operator's and service manuals.**  
Be sure all decals are in place and legible.  
Be sure safety, operator's and responsibilities manuals are complete, legible and in the storage container located on the platform.

114258

**DANGER**

**Burn Hazard**  
Fuel and fumes can explode and burn.

No smoking. No flame. Stop engine.

28236

**WARNING**

**Read and understand Operator's Manual, Responsibilities Manual and Safety Manual and all safety signs before using or maintaining machine.**  
If you do not understand the information in the manuals, consult your supervisor, the owner or the manufacturer.



# General Safety

97602

**WARNING**

**Explosion Hazard**  
Death or serious injury can result from the use of either or other high energy starting aids.

Do not use either or other high energy starting aids on machines equipped with glow plugs.

97602 B

82558

**WARNING**

**Injection Hazard**  
Escaping fluid under pressure can penetrate skin, causing serious injury.

Relieve pressure before disconnecting hydraulic lines. Keep away from leaks and pin holes. Use a piece of cardboard or paper to search for leaks. Do not use hand.

Fluid injected into skin must be surgically removed within a few hours by a doctor familiar with this type of injury or gangrene will result.

82558 B

31788

**DANGER**

**Explosion / Burn Hazard**  
Ignition of explosive gases or contact with corrosive acid will cause death, burns or blindness

Keep all open flames and sparks away. Wear personal protective equipment, including face shield, gloves and long sleeve shirt.

**READ MANUALS**  
Read all manuals prior to operation.

**DO NOT OPERATE** equipment if you do not understand the information in the manuals. Consult your supervisor, the owner or the manufacturer.

31788 C

72853

**DANGER**

**Failure to read, understand and obey the safety rules will result in death or serious injury.**

The operator is responsible for safe machine operation. This includes:

- 1. Avoid hazardous situations.
- 2. Always perform a preoperation inspection.
- 3. Always perform function tests prior to use.
- 4. Respect the work limits.
- 5. Only use the machine as it was intended.

- Do not operate unless:
- You read, understand and obey manufacturer's instructions and safety rules — safety and operator's manual and decals
- You know safety rules
- You are properly trained to safely operate this machine.

114385

**DANGER**

**Electrocution Hazard**  
Death or injury can result from contacting electric power lines.

Always contact the electric power line owner. The electric power shall be disconnected or the power lines moved or insulated before machine operations begin.

| Maintain required clearance. |                    |         |
|------------------------------|--------------------|---------|
| Line voltage                 | Required clearance |         |
| 0 to 50KV                    | 10 ft              | 3.05 m  |
| 50KV to 200KV                | 15 ft              | 4.60 m  |
| 200KV to 350KV               | 20 ft              | 6.10 m  |
| 350KV to 500KV               | 25 ft              | 7.62 m  |
| 500KV to 750KV               | 30 ft              | 10.67 m |
| 750KV to 1000KV              | 45 ft              | 13.72 m |

114385 A

31060

**DANGER**

**Tip-over Hazard**  
Altering or disabling limit switches can result in machine tip-over. Machine tip-over will result in death or serious injury.

Do not alter or disable limit switch(s).

31060 C

72186

**WARNING**

**Crushing hazard.**  
Lowering the outriggers onto a person's foot may cause serious injury.

Stay clear. Be sure that nothing is under the outriggers before lowering.

72186 B

44255

**DANGER**

**Crushing Hazard**  
Contact with moving parts will result in death or serious injury.

Keep away from moving parts.

44255 C

28175

**WARNING**

**Compartment access is restricted.**  
Contact with components under any cover may result in serious injury.

Only trained maintenance personnel should access compartments. Access by operator is only advised when performing Pre-operation Inspection. All compartments must remain closed and secured during operation.

28175 H

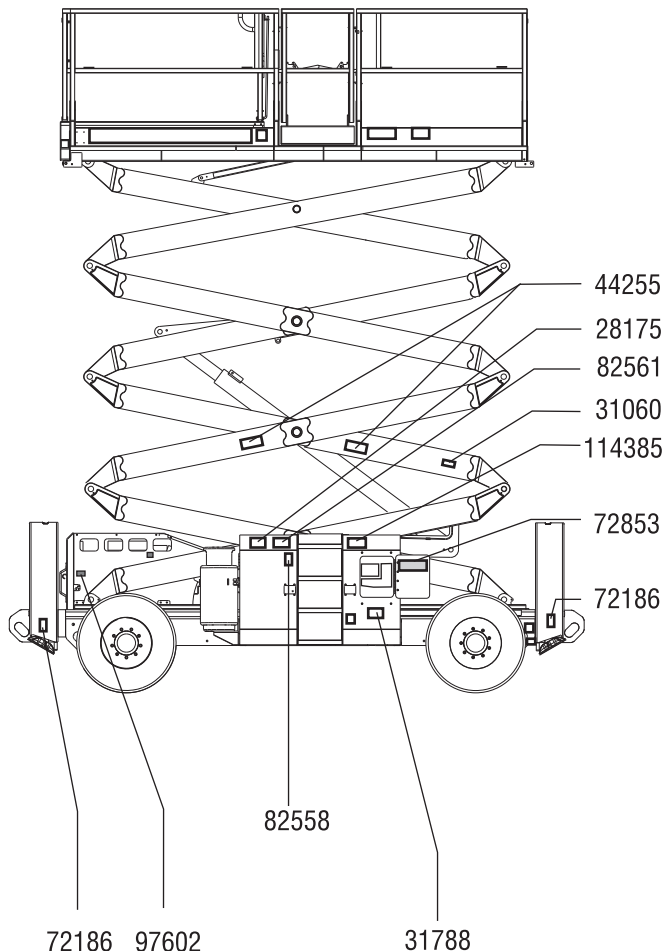



## Personal Safety

### Personal Fall Protection

Personal fall protection equipment (PFPE) is not required when operating this machine. If PFPE is required by job site or employer rules, the following shall apply:

All PFPE must comply with applicable governmental regulations, and must be inspected and used in accordance with the manufacturer's instructions.

## Work Area Safety

### ⚠️ Electrocuting Hazards

This machine is not electrically insulated and will not provide protection from contact with or proximity to electrical current.

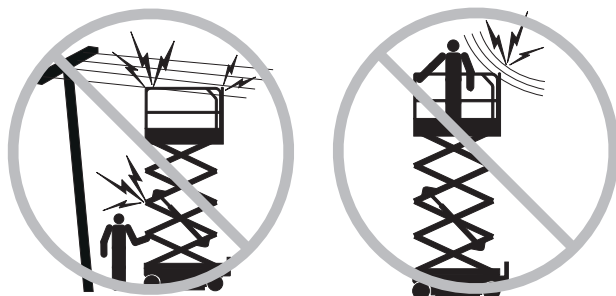

Maintain safe distances from electrical power lines and apparatus in accordance with applicable governmental regulations and the following chart.

| Line Voltage  | Required Clearance |         |
|---------------|--------------------|---------|
| 0 to 50KV     | 10 ft              | 3.05 m  |
| 50 to 200KV   | 15 ft              | 4.60 m  |
| 200 to 350KV  | 20 ft              | 6.10 m  |
| 350 to 500KV  | 25 ft              | 7.62 m  |
| 500 to 750KV  | 35 ft              | 10.67 m |
| 750 to 1000KV | 45 ft              | 13.72 m |

Allow for platform movement, electrical line sway or sag and beware of strong or gusty winds.

Keep away from the machine if it contacts energized power lines. Personnel on the ground or in the platform must not touch or operate the machine until energized power lines are shut off.

Do not operate the machine during lightning or storms.

Do not use the machine as a ground for welding.

### ⚠️ Tip-over Hazards

Occupants, equipment and materials must not exceed the maximum platform capacity.

#### Machine with capacity indicator:

The maximum capacity varies with the height of the platform.

| Maximum capacity - GS-3384 and GS-3390 |                  |
|--|------------------|
| Maximum occupants                      | 7                |
| Height of Platform                     | Maximum Capacity |
| 10.1 m                                 | 1134 kg          |
| 8.5 m                                  | 1683 kg          |
| 6.4 m                                  | 1878 kg          |
| 4.2 m                                  | 1683 kg          |
| 2 m                                    | 1134 kg          |

| Maximum capacity - GS-4390 |                  |
|----------------------------|------------------|
| Maximum occupants          | 7                |
| Height of Platform         | Maximum Capacity |
| 13.1 m                     | 680 kg           |
| 10.1 m                     | 1170 kg          |
| 8 m                        | 1286 kg          |
| 5.4 m                      | 1170 kg          |
| 2.9 m                      | 680 kg           |

| Maximum capacity - GS-5390 |                  |
|----------------------------|------------------|
| Maximum occupants          | 4                |
| Height of Platform         | Maximum Capacity |
| 16.2 m                     | 680 kg           |
| 13.6 m                     | 1264 kg          |
| 11 m                       | 1410 kg          |
| 8.2 m                      | 1264 kg          |
| 2.5 m                      | 680 kg           |

## Work Area Safety

Do not raise the platform unless the machine is on a firm, level surface.



Do not depend on the tilt alarm as a level indicator. The tilt alarm sounds on the chassis and in the platform when the machine is on a severe slope.

If the tilt alarm sounds:  
Lower the platform. Move the machine to a firm, level surface. If the tilt alarm sounds when the platform is raised, use extreme caution to lower the platform.

Do not alter or disable the limit switches.

Do not drive over 1.1 km/h with the platform raised.

Use extreme care and slow speeds while driving the machine in the stowed position across uneven terrain, debris, unstable or slippery surfaces and near holes and drop-offs.

Do not use the platform controls to free a platform that is caught, snagged or otherwise prevented from normal motion by an adjacent structure. All personnel must be removed from the platform before attempting to free the platform using the ground controls.



Do not push off or pull toward any object outside of the platform.

|                                       |       |
|---------------------------------------|-------|
| <b>Maximum allowable manual force</b> | 400 N |
|---------------------------------------|-------|

Do not tie the platform to adjacent structures.

Do not place loads outside the platform perimeter.

Do not alter or disable machine components that in any way affect safety and stability.

Do not modify or alter an aerial work platform without prior written permission from the manufacturer. Mounting attachments for holding tools or other materials onto the platform, toeboards or guard rail system can increase the weight in the platform and the surface area of the platform or the load.

## Work Area Safety

Do not replace items critical to machine stability with items of different weight or specification.

Do not raise the platform when wind speeds may exceed 12.5 m/s. If wind speeds exceed 12.5 m/s when the platform is raised, lower the platform and do not continue to operate the machine.

Do not operate the machine in strong or gusty winds. Do not increase the surface area of the platform or the load. Increasing the area exposed to the wind will decrease machine stability.

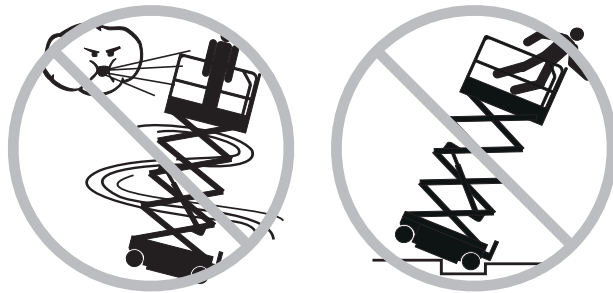

Do not drive the machine on or near uneven terrain, unstable surfaces or other hazardous conditions with the platform raised.

Do not place or attach fixed or overhanging loads to any part of this machine.



Do not place ladders or scaffolds in the platform or against any part of this machine.

Do not transport tools and materials unless they are evenly distributed and can be safely handled by person(s) in the platform.

Do not use the machine on a moving or mobile surface or vehicle.

Be sure all tires are in good condition, air-filled tires are properly inflated and lug nuts are properly tightened.

Do not use the machine as a crane.

Do not push the machine or other objects with the platform.

Do not contact adjacent structures with the platform.

## Work Area Safety

### ⚠️ Operation on Slopes Hazards

Do not drive the machine on a slope that exceeds the slope and side slope rating of the machine. Slope rating applies to machines in the stowed position.

---

#### Maximum slope rating, stowed position

|                           |           |
|---------------------------|-----------|
| GS-3384, GS-3390, GS-4390 | 50% (26°) |
|---------------------------|-----------|

|         |           |
|---------|-----------|
| GS-5390 | 40% (22°) |
|---------|-----------|

---

#### Maximum side slope rating, stowed position

|                           |           |
|---------------------------|-----------|
| GS-3384, GS-3390, GS-4390 | 50% (26°) |
|---------------------------|-----------|

|         |           |
|---------|-----------|
| GS-5390 | 40% (22°) |
|---------|-----------|

Note: Slope rating is subject to ground conditions and adequate traction.

### ⚠️ Fall Hazards

The guard rail system provides fall protection. If occupant(s) of the platform are required to wear personal fall protection equipment (PFPE) due to job site or employer rules, PFPE equipment and its use shall be in accordance with the PFPE manufacturer's instructions and applicable governmental requirements.

Do not sit, stand or climb on the platform guard rails. Maintain a firm footing on the platform floor at all times.



Do not climb down from the platform when raised.

Keep the platform floor clear of debris.

Close the entry gate before operating.

Do not operate the machine unless the guard rails are properly installed and the entry is secured for operation.

## Work Area Safety

### Collision Hazards

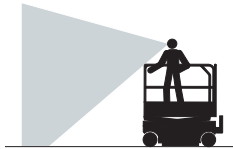

Be aware of limited sight distance and blind spots when driving or operating.

Be aware of the extended platform position when moving the machine.

The machine must be on a level surface or secured before releasing the brakes.

Operators must comply with employer, job site and governmental rules regarding use of personal protective equipment.

Check the work area for overhead obstructions or other possible hazards.



Be aware of crushing hazards when grasping the platform guard rail.

Observe and use color-coded direction arrows on the platform controls and platform decal plate for drive and steer functions.

Do not operate a machine in the path of any crane or moving overhead machinery unless the controls of the crane have been locked out and/or precautions have been taken to prevent any potential collision.

No stunt driving or horseplay while operating a machine.

Do not lower the platform unless the area below is clear of personnel and obstructions.



Limit travel speed according to the condition of the ground surface, congestion, slope, location of personnel and any other factors which may cause collision.

### ⚠ Bodily Injury Hazards

Always operate the machine in a well-ventilated area to avoid carbon monoxide poisoning.

Do not operate the machine with a hydraulic oil or air leak. An air leak or hydraulic leak can penetrate and/or burn skin.

Improper contact with components under any cover will cause serious injury. Only trained maintenance personnel should access compartments. Access by the operator is only advised when performing a pre-operation inspection. All compartments must remain closed and secured during operation.

### ⚠ Component Damage Hazards

Do not use any battery or charger greater than 12V to jump-start the engine.

Do not use the machine as a ground for welding.

## Work Area Safety

### **⚠ Explosion and Fire Hazards**

Do not start the engine if you smell or detect liquid petroleum gas (LPG), gasoline, diesel fuel or other explosive substances.

Do not refuel the machine with the engine running.

Refuel the machine and charge the battery only in an open, well-ventilated area away from sparks, flames and lighted tobacco.

Do not operate the machine in hazardous locations or locations where potentially flammable or explosive gases or particles may be present.

Do not spray ether into engines equipped with glow plugs.

### **⚠ Damaged Machine Hazards**

Do not use a damaged or malfunctioning machine.

Conduct a thorough pre-operation inspection of the machine and test all functions before each work shift. Immediately tag and remove from service a damaged or malfunctioning machine.

Be sure all maintenance has been performed as specified in this manual and the appropriate Genie service manual.

Be sure all decals are in place and legible.

Be sure the operator's, safety and responsibilities manuals are complete, legible and in the storage container located on the platform.

### **⚠ Crushing Hazards**

Keep hands and limbs out of scissors.

Use common sense and planning when operating the machine with the controller from the ground. Maintain safe distances between the operator, the machine and fixed objects.

Maintain a firm grasp on the platform rail when pulling the rail pins. Do not allow the platform guard rails to fall.

### **⚠ Outrigger Safety**

#### **Tip-over Hazards**

Do not lower the outriggers unless the machine is on a firm surface. Avoid drop-offs, holes, unstable or slippery surfaces and other possible hazardous conditions.

When the auto level function is not being used and the outriggers are being lowered individually, the steer-end outriggers must be lowered first.

Do not raise the platform unless the machine is level. Do not set the machine up on a surface where it cannot be leveled using only the outriggers.

Do not raise the platform unless all four outriggers are properly lowered, the footpads are in firm contact with the ground and the machine is level.

Do not adjust the outriggers while the platform is raised.

Do not drive while the outriggers are lowered.

## Work Area Safety

### Battery Safety

---

#### Burn Hazards

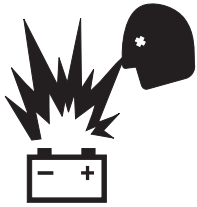

Batteries contain acid. Always wear protective clothing and eye wear when working with batteries.



Avoid spilling or contacting battery acid. Neutralize battery acid spills with baking soda and water.

Do not expose the batteries or the charger to water or rain during charging.

#### Explosion Hazards



Keep sparks, flames and lighted tobacco away from batteries. Batteries emit an explosive gas.

The battery tray should remain open during the entire charging cycle.



Do not contact the battery terminals or the cable clamps with tools that may cause sparks.

#### Component Damage Hazard

Do not use any battery charger greater than 24V to charge the batteries.



## Legend

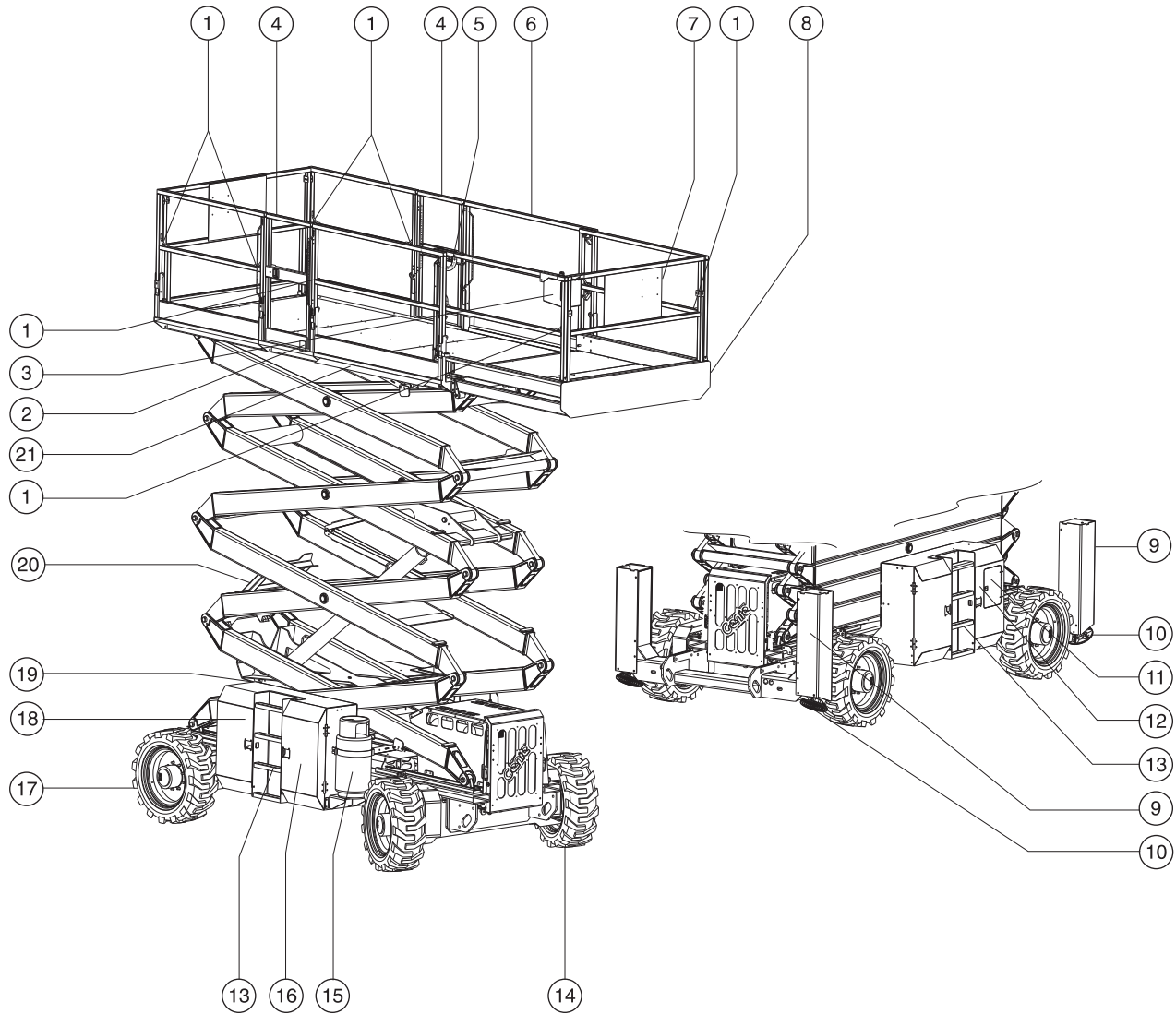

- 1 Lanyard anchorage point
- 2 GFCI outlet
- 3 Platform controls
- 4 Platform entry gate
- 5 Platform extension lock handle
- 6 Platform guard rails
- 7 Manual storage container
- 8 Platform extension

- 9 Outrigger housing (if equipped)
- 10 Outrigger footpad (if equipped)
- 11 Ground controls with LCD readout screen
- 12 Tilt alarm (behind ground control panel)
- 13 Entry ladder
- 14 Steer tire

- 15 LPG tank
- 16 Hydraulic tank (behind cover)
- 17 Non-steer tire
- 18 Fuel tank (behind cover)
- 19 Power to platform (hidden from view)
- 20 Safety arm (hidden from view)
- 21 Capacity indicator



## Controls

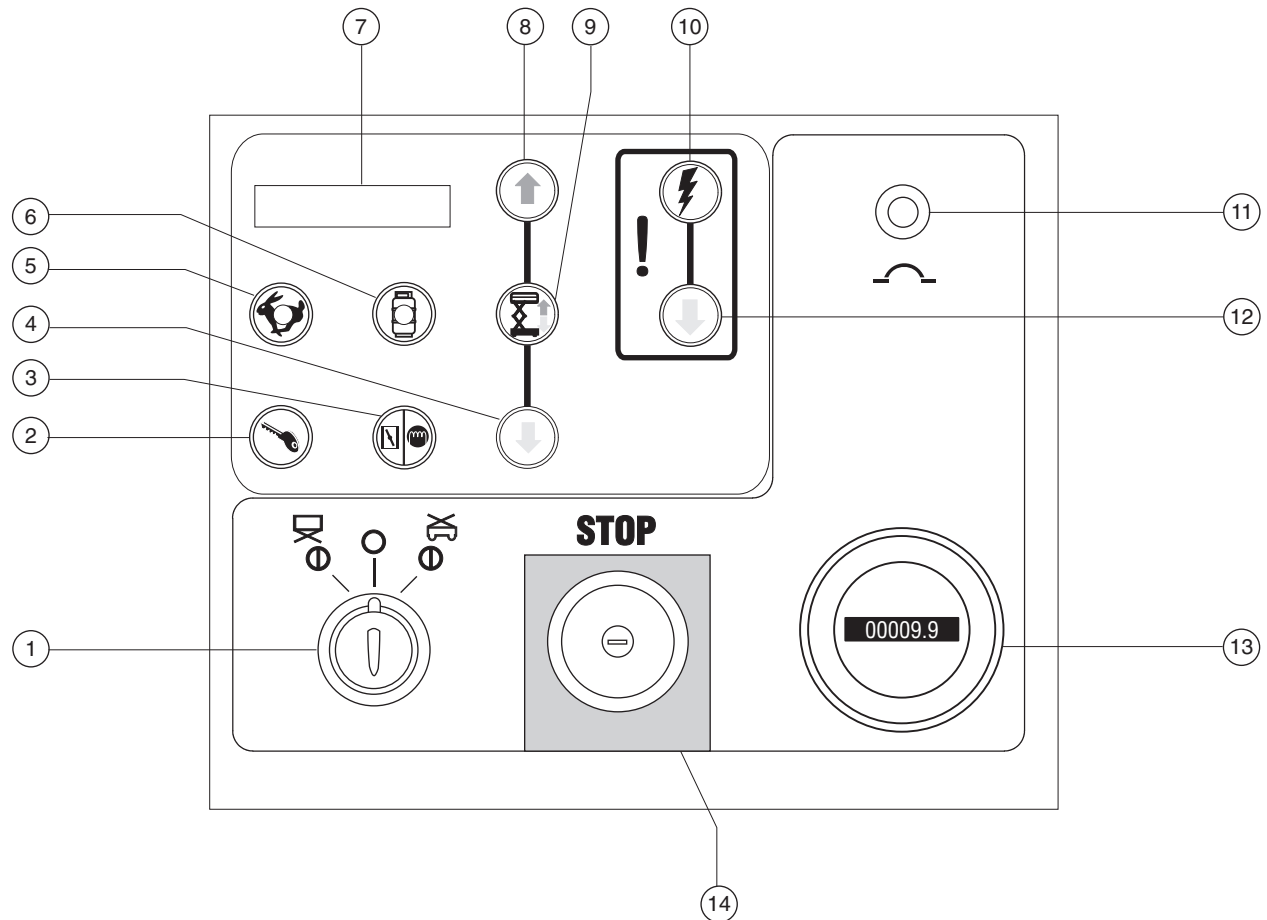

### Ground Control Panel

- |   |  |    |   |
|---|--|----|---|
| 1 | Key switch for platform/off/ground control selection                 | 8  | Platform up button                          |
| 2 | Engine start button  | 9  | Lift function enable button                 |
| 3 | Gasoline/LPG models: Choke button<br>Diesel models: Glow plug button | 10 | Emergency lowering function enable button   |
| 4 | Platform down button   | 11 | 20 amp circuit breaker for controls circuit |
| 5 | Idle select button with indicator light                              | 12 | Emergency lowering down button              |
| 6 | Gasoline/LPG models: LPG select button with indicator light          | 13 | Hour meter                                  |
| 7 | LCD readout screen   | 14 | Red Emergency Stop button                   |

## Controls

### Ground Control Panel

- 1 Key switch for platform/off/ground selection  
Turn the keyswitch to the platform position and the platform controls will operate. Turn the keyswitch to the off position and the machine will be off. Turn the keyswitch to the ground position and the ground controls will operate.
- 2 Engine start button  
Press this button to start the engine.
- 3 Gasoline/LPG models: Choke button  
Press this button to activate the choke.  
Diesel models: Glow plug button  
Press this button to activate the glow plugs.
- 4 Platform down button  
Press this button and the platform will lower.
- 5 Engine idle select button with indicator light  
Press this button to select the engine idle setting. Light on indicates high idle is selected. Light off indicates low idle is selected.
- 6 Gasoline/LPG models: LPG select button with indicator light  
Press this button to select fuel. Light on indicates that LPG is selected. Light off indicates gasoline is selected.
- 7 LCD readout screen
- 8 Platform up button  
Press this button and the platform will raise.
- 9 Lift function enable button  
Press this button to activate the lift function.
- 10 Emergency lowering function enable button  
Press this button to activate the emergency lowering function.
- 11 20 amp circuit breaker for controls circuit
- 12 Emergency lowering down button  
Press this button to activate the emergency lowering down function.
- 13 Hour meter  
Indicates the number of hours the machine has been put into use.
- 14 Red Emergency Stop button  
Push in the red Emergency Stop button to the off position to stop all functions. Pull out the red Emergency Stop button to the on position to operate the machine.

## Controls

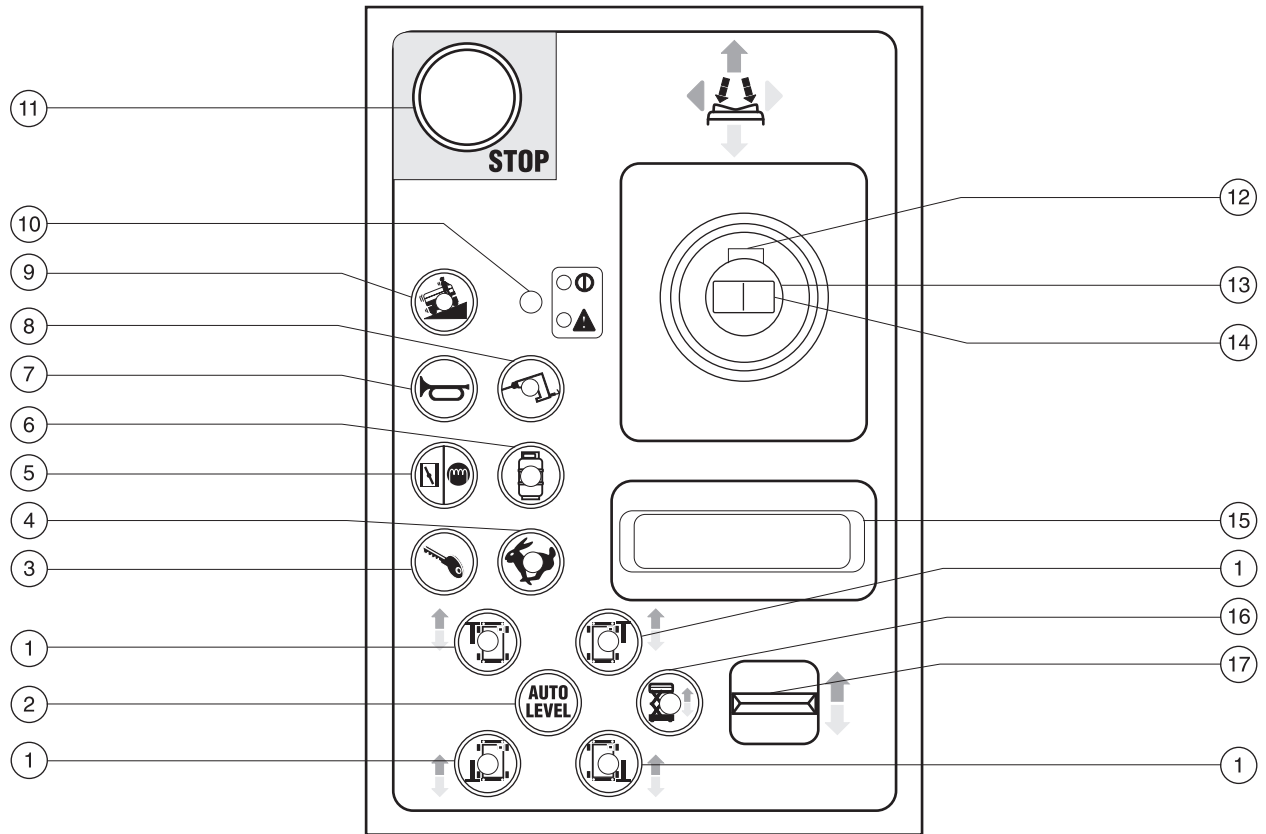

### Platform Controls

- |   |  |   |  |    |   |
|---|--|---|--|----|---|
| 1 | Outrigger function enable button with indicator light                      | 6 | Gasoline/LPG models: LPG operation button with indicator light                   | 10 | Green power light/Red error indicator light |
| 2 | Outrigger auto level button  | 7 | Horn button  | 11 | Red Emergency Stop button                   |
| 3 | Engine start button  | 8 | Generator select button with indicator light                                     | 12 | Function enable switch                      |
| 4 | Engine idle select button with indicator light                             | 9 | Machine on incline button with indicator light: Low speed operation for inclines | 13 | Proportional control handle for drive       |
| 5 | Gasoline/LPG models:<br>Choke button<br>Diesel models:<br>Glow plug button |   |  |    |   |

## Controls

### Platform control panel

- 1 Outrigger function enable button with indicator light  
Press this button to activate the individual outrigger up/down function.
- 2 Outrigger auto level button  
Press this button to activate the auto level function.
- 3 Engine start button  
Press this button to start the engine.
- 4 Engine idle select button with indicator light  
Press this button to select the engine idle setting. Indicator light off: low idle Indicator light on: High idle
- 5 Gasoline/LPG models: Choke button  
Press this button to aid in starting the engine in cold conditions.  
Diesel models: Glow plug button  
Press this button to aid in starting the engine in cold conditions.
- 6 Gasoline/LPG models: LPG operation button with indicator light  
Press this button to select LPG.
- 7 Horn button  
Press this button and the horn will sound. Release the button and the horn will stop
- 8 Generator select button with indicator light  
Press this button to turn the generator on. Indicator light will be on. Press the button again to turn the generator off.
- 9 Machine on incline button with indicator light: Low speed operation for inclines  
Press this button to select low speed operation for inclines.
- 10 Green power light/Red error indicator light  
Green power light is on when Red Emergency Stop button is pulled out to the on position.  
If red error indicator light is on, push in and pull out the Red Emergency Stop button to set the system. If the light stays red, tag and remove the machine from service.
- 11 Red Emergency Stop button  
Push in the Red Emergency Stop button to the off position to stop all functions and turn the engine off. Pull out the Red Emergency Stop button to the on position to operate the machine.
- 12 Function enable switch  
Press and hold the function enable switch to enable the drive function.
- 13 Proportional control handle for drive function  
Move the control handle in the direction indicated by the blue arrow on the control panel and the machine will move in the direction that the blue arrow points. Move the control handle in the direction indicated by the yellow arrow on the control panel and the machine will move in the direction that the yellow arrow points.

## Controls

### 14 Thumb rocker switch for steer function

Press the left side of the thumb rocker and the machine will steer to the left.

Press the right side of the thumb rocker and the machine will steer to the right.

### 15 Wrist rest

### 16 Lift function enable button with indicator light

Press this button to enable the lift function.

### 17 Proportional rocker switch for outrigger up/down and platform up/down

With the auto level button indicator light on, move the rocker switch up and the outriggers will raise. Move the rocker switch down and the outriggers will lower.

With an individual outrigger enable button indicator light on, move the rocker switch up and the outrigger will raise. Move the rocker switch down and the outrigger will lower.

With the lift function enable button indicator light on, move the rocker switch up and the platform will raise. Move the rocker switch down and the platform will lower.

## Inspection



---

### Do Not Operate Unless:

- You learn and practice the principles of safe machine operation contained in this operator's manual.
  - 1 Avoid hazardous situations.
  - 2 Always perform a pre-operation inspection.**
  - Know and understand the pre-operation inspection before going on to the next section.**
  - 3 Always perform function tests prior to use.
  - 4 Inspect the workplace.
  - 5 Only use the machine as it was intended.

### Pre-Operation Inspection Fundamentals

It is the responsibility of the operator to perform a pre-operation inspection and routine maintenance.

The pre-operation inspection is a visual inspection performed by the operator prior to each work shift. The inspection is designed to discover if anything is apparently wrong with a machine before the operator performs the function tests.

The pre-operation inspection also serves to determine if routine maintenance procedures are required. Only routine maintenance items specified in this manual may be performed by the operator.

Refer to the list on the next page and check each of the items.

If damage or any unauthorized variation from factory delivered condition is discovered, the machine must be tagged and removed from service.

Repairs to the machine may only be made by a qualified service technician, according to the manufacturer's specifications. After repairs are completed, the operator must perform a pre-operation inspection again before going on to the function tests.

Scheduled maintenance inspections shall be performed by qualified service technicians, according to the manufacturer's specifications and the requirements listed in the responsibilities manual.

## Inspections

### Pre-operation Inspection

- Be sure that the operator's, safety and responsibilities manuals are complete, legible and in the storage container located in the platform.
- Be sure that all decals are legible and in place. See Decals section.
- Check for engine oil leaks and proper oil level. Add oil if needed. See Maintenance section.
- Check for hydraulic oil leaks and proper oil level. Add oil if needed. See Maintenance section.
- Check for engine coolant leaks and proper level of coolant. Add coolant if needed. See Maintenance section.
- Check for battery fluid leaks and proper fluid level. Add distilled water if needed. See Maintenance section.

Check the following components or areas for damage, improperly installed or missing parts and unauthorized modifications:

- Electrical components, wiring and electrical cables
- Hydraulic hoses, fittings, cylinders and manifolds
- Fuel and hydraulic tanks
- Drive motors
- Wear pads
- Tires and wheels
- Engine and related components
- Limit switches, alarms and horn
- Platform overload components

- Nuts, bolts and other fasteners
- Platform entry gate
- Beacon and alarms (if equipped)
- Brake release components
- Safety arm
- Platform extension(s)
- Scissor pins and retaining fasteners
- Platform control joystick
- Generator (if equipped)
- Outrigger housings and footpads (if equipped)

Check entire machine for:

- Cracks in welds or structural components
- Dents or damage to machine
- Excessive rust, corrosion or oxidation
- Be sure that all structural and other critical components are present and all associated fasteners and pins are in place and properly tightened
- Side rails are installed and snap pins and bolts are fastened



## Inspections



---

### Do Not Operate Unless:

- You learn and practice the principles of safe machine operation contained in this operator's manual.
  - 1 Avoid hazardous situations.
  - 2 Always perform a pre-operation inspection.
  - 3 Always perform function tests prior to use.**
- Know and understand the function tests before going on to the next section.**
  - 4 Inspect the workplace.
  - 5 Only use the machine as it was intended.

### Function Tests Fundamentals

The function tests are designed to discover any malfunctions before the machine is put into service. The operator must follow the step-by-step instructions to test all machine functions.

A malfunctioning machine must never be used. If malfunctions are discovered, the machine must be tagged and removed from service. Repairs to the machine may only be made by a qualified service technician, according to the manufacturer's specifications.

After repairs are completed, the operator must perform a pre-operation inspection and function tests again before putting the machine into service.

## Inspections

- 1 Select a test area that is firm, level and free of obstruction.

### At the Ground Controls

- 2 Pull out the platform and ground red Emergency Stop buttons to the on position.
  - 3 Turn the key switch to ground control.
- ⦿ Result: The LCD screen will come on and display `SYSTEM READY`.

Note: In cold climates, the LCD readout screen will need to warm up before the display appears.

- 4 Start the engine. See Operating Instructions section.

### Test Emergency Stop

- 5 Push in the ground red Emergency Stop button to the off position.
- ⦿ Result: The engine should turn off and no functions should operate.
- 6 Pull out the red Emergency Stop button to the on position and restart the engine.

### Test the Up/Down Functions

The audible warnings on this machine and the standard horn all come from the same central alarm. The horn is a constant tone. The descent alarm sounds at 60 beeps per minute. The alarm that goes off when the machine is not level sounds at 180 beeps per minute.

- 7 Do not push the lift function enable button. Push and hold the platform up button.

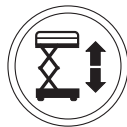

- ⦿ Result: The platform should not raise.

- 8 Push and hold the lift function enable button. Push and hold the platform up button.

- ⦿ Result: The platform should raise.

- 9 Push and hold the lift function enable button. Push and hold the platform down button.

- ⦿ Result: The platform should lower. The descent alarm should sound while the platform is lowering.

## At the Platform Controls

### Test Emergency Stop

- 10 Push in the platform red Emergency Stop button to the off position.

- ⦿ Result: The engine should shut off and no functions should operate.

- 11 Pull the red Emergency Stop button out to the on position.

- ⦿ Result: The indicator light should be green.



### Test the Horn

- 12 Push the horn button.

- ⦿ Result: The horn should sound.

## Inspections

### Test Up/Down Functions and Function Enable

- 13 Start the engine.
- 14 Activate the up/down rocker switch in the direction indicated by the blue arrow.
  - ⦿ Result: The platform should not raise.
- 15 Push and hold the lift function enable button.
- 16 Activate the up/down rocker switch in the direction indicated by the blue arrow.
  - ⦿ Result: The platform should raise.
- 17 Push and hold the lift function enable button.
- 18 Activate the up/down rocker switch in the direction indicated by the yellow arrow.
  - ⦿ Result: The platform should lower. The descent alarm should sound while the platform is lowering.



### Test the Steering

- Note: When performing the steer and drive function tests, stand in the platform facing the steer end of the machine.
- 19 Press and hold the function enable switch on the control handle.
  - 20 Depress the thumb rocker switch on top of the control handle in the direction identified by the blue triangle on the control panel.
    - ⦿ Result: The steer wheels should turn in the direction that the blue triangle points on the control panel.
  - 21 Depress the thumb rocker switch in the direction identified by the yellow triangle on the control panel.
    - ⦿ Result: The steer wheels should turn in the direction that the yellow triangle points on the control panel.

## Inspections

### Test Drive and Braking

- 22 Press and hold the function enable switch on the control handle.
- 23 Slowly move the control handle in the direction indicated by the blue arrow on the control panel until the machine begins to move, then return the handle to the center position.
  - ⦿ Result: The machine should move in the direction that the blue arrow points on the control panel, then come to an abrupt stop.
- 24 Press and hold the function enable switch on the control handle.
- 25 Slowly move the control handle in the direction indicated by the yellow arrow on the control panel until the machine begins to move, then return the handle to the center position.
  - ⦿ Result: The machine should move in the direction that the yellow arrow points on the control panel, then come to an abrupt stop.

Note: The brakes must be able to hold the machine on any slope it is able to climb.

### Test Limited Drive Speed

- 26 Push and hold the lift function enable button. Raise the platform approximately 1.8 m from the ground.
- 27 Press and hold the function enable switch on the control handle.
- 28 Slowly move the control handle to the full drive position.
  - ⦿ Result: The maximum achievable drive speed with the platform raised should not exceed 31 cm/s.

If the drive speed with the platform raised exceeds 31 cm/s, immediately tag and remove the machine from service.

### Test the Up Limit Switch and the Outriggers - GS-5390

- 34 Push and hold the lift function enable button. Raise the platform.
  - ⦿ Result: The platform should raise to 9.1 m and then stop. The platform should not raise above 9.1 m unless the outriggers are lowered.
- 35 Drive the machine forward.
  - ⦿ Result: The drive function should not operate.

## Inspections

36 Lower the platform. If the platform is higher than 3.6 m from the ground, the outriggers will not lower.

37 Push and hold the auto level button.



38 Activate the up/down rocker switch in the down direction.

⦿ Result: The outriggers should extend and level the machine. A beep will sound when the machine is level.

39 Raise the platform.

⦿ Result: The platform should raise to full height.

40 Lower the platform.

41 Push and hold the auto level button and raise the outriggers.

### Test the Tilt Sensor Operation

Note: Perform this test from the ground with the platform controller. Do not stand in the platform.

29 Fully lower the platform.

30 Drive both wheels on one side onto a 18 cm block or onto a curb.

31 Raise the platform at least 3.6 m.

⦿ Result: The platform should stop and the tilt alarm will sound at 180 beeps per minute. The indicator light on the lift function enable button will be red.

32 Move the drive control handle in the direction indicated by the blue arrow, then move the drive control handle in the direction indicated by the yellow arrow.

⦿ Result: The drive function should not work in either direction.

33 Lower the platform and drive the machine off the block.

## Inspections

### Test the Emergency Lowering

- 34 Push and hold the lift function enable button and raise the platform approximately 60 cm.
- 35 Push in the red Emergency Stop button to shut off the engine.
- 36 Pull out the red Emergency Stop button to the on position.
- 37 Push and hold the lift function enable button. Activate the up/down rocker switch in the direction indicated by the yellow arrow.

⦿ Result: The platform should lower.

### Test the Oscillate System

Note: Perform this test from the ground with the platform controller. Do not stand in the platform.

### Test the Oscillate System (stowed position)

- 38 Drive the left steer tire up onto a 4 in / 10 cm high ramp.
- ⦿ Result: All four tires should maintain firm contact with the ground.
- 39 Drive the right steer tire up onto a 4 in / 10 cm high ramp.
- ⦿ Result: All four tires should maintain firm contact with the ground.

Note: Verify that there are no fault codes shown on the ground control display.

### Test the Oscillate System (elevated position)

- 40 Push and hold the function enable button and raise the platform approximately 8 to 9 ft / 2.4 to 2.7 m.
- 41 Drive the left steer tire up onto a 4 in / 10 cm high ramp.
- ⦿ Result: All four tires should maintain firm contact with the ground.
- 42 Drive the right steer tire up onto a 4 in / 10 cm high ramp.
- ⦿ Result: All four tires should maintain firm contact with the ground.

Note: Verify that there are no fault codes shown on the ground control display.

## Inspections



### Do Not Operate Unless:

- You learn and practice the principles of safe machine operation contained in this operator's manual.

- 1 Avoid hazardous situations.
- 2 Always perform a pre-operation inspection.
- 3 Always perform function tests prior to use.

#### 4 Inspect the workplace.

**Know and understand the workplace inspection before going on to the next section.**

- 5 Only use the machine as it was intended.

### Workplace Inspection

Be aware of and avoid the following hazardous situations:

- drop-offs or holes
- bumps, floor obstructions or debris
- sloped surfaces
- unstable or slippery surfaces
- overhead obstructions and high voltage conductors
- hazardous locations
- inadequate surface support to withstand all load forces imposed by the machine
- wind and weather conditions
- the presence of unauthorized personnel
- other possible unsafe conditions

## Fundamentals

The workplace inspection helps the operator determine if the workplace is suitable for safe machine operation. It should be performed by the operator prior to moving the machine to the workplace.

It is the operator's responsibility to read and remember the workplace hazards, then watch for and avoid them while moving, setting up and operating the machine.

## Inspections

### Inspection for Decals with Words

Determine whether the decals on your machine have words or symbols. Use the appropriate inspection to verify that all decals are legible and in place.

| Part No. | Description  | Quantity |
|----------|--|----------|
| 25994    | Warning - Component Damage                               | 1        |
| 28158    | Label - Unleaded   | 1        |
| 28159    | Label - Diesel   | 1        |
| 28160    | Label - LPG  | 1        |
| 28160    | Label - LPG<br>(1 additional with extra LPG tank option) | 1        |
| 28174    | Label - Power to Platform, 230V                          | 3        |
| 28175    | Caution - Compartment Access                             | 1        |
| 28176    | Notice - Missing Manuals                                 | 1        |
| 28235    | Label - Power to Platform, 115V                          | 3        |
| 28236    | Warning - Failure To Read . . .                          | 1        |
| 31060    | Danger - Do Not Alter Limit Switch                       | 1        |
| 40434    | Label - Lanyard Anchorage                                | 8        |
| 43618    | Label - Directional arrows                               | 1        |
| 43619    | Label - Safety Arm                                       | 1        |
| 44255    | Danger - Crushing Hazard                                 | 4        |
| 44736    | Danger - Tilt Alarm                                      | 1        |
| 44981    | Label - Air Line to Platform                             | 2        |
| 52431    | Label - Ground Control Panel                             | 1        |
| 52475    | Label - Transport Tie-down                               | 4        |
| 52494    | Caution - Crushing Hazard - Rails                        | 1        |
| 52967    | Cosmetic - 4x4   | 2        |
| 62748    | Cosmetic - Genie GS-4390                                 | 2        |
| 65061    | Cosmetic - Genie GS-5390                                 | 2        |
| 65063    | Notice - Tire Specifications                             | 4        |

| Part No. | Description                                      | Quantity |
|----------|--|----------|
| 72186    | Caution - Crushing Hazard                        | 4        |
| 72818    | Label - Test Mode Switch                         | 1        |
| 72853    | Danger - Improper Use Hazard                     | 1        |
| 72868    | Label - Engine Tray Prop                         | 1        |
| 82210    | Cosmetic - Genie GS-3384                         | 2        |
| 82215    | Notice - Tire Specifications                     | 4        |
| 82224    | Label - HOT, Ford Tier II Engines                | 1        |
| 82366    | Label - Chevron Rando                            | 1        |
| 82417    | Platform Control Panel                           | 1        |
| 82418    | Ground Control Panel                             | 1        |
| 82557    | Label - Platform Controls Location               | 1        |
| 82558    | Warning - Skin Injection Hazard                  | 1        |
| 82559    | Notice - Annual Inspection                       | 1        |
| 82561    | Danger - Crushing Hazard                         | 2        |
| 82757    | Danger - Outrigger Safety and Instructions       | 1        |
| 82793    | Notice - Operating Instructions, Ground          | 1        |
| 82798    | Ground Control Panel                             | 1        |
| 82809    | Label - Wheel Load, GS-3384                      | 4        |
| 82824    | Label - Wheel Load, GS-3390, GS-4390             | 4        |
| 82825    | Label - Wheel Load, GS-5390                      | 4        |
| 82867    | Label - Capacity Indicator,<br>GS-3384 & GS-3390 | 1        |
| 82868    | Label - Capacity Indicator, GS-4390              | 1        |
| 82870    | Label - Capacity Indicator, GS-5390              | 1        |

Decal inspection continued on following page.



# Inspections

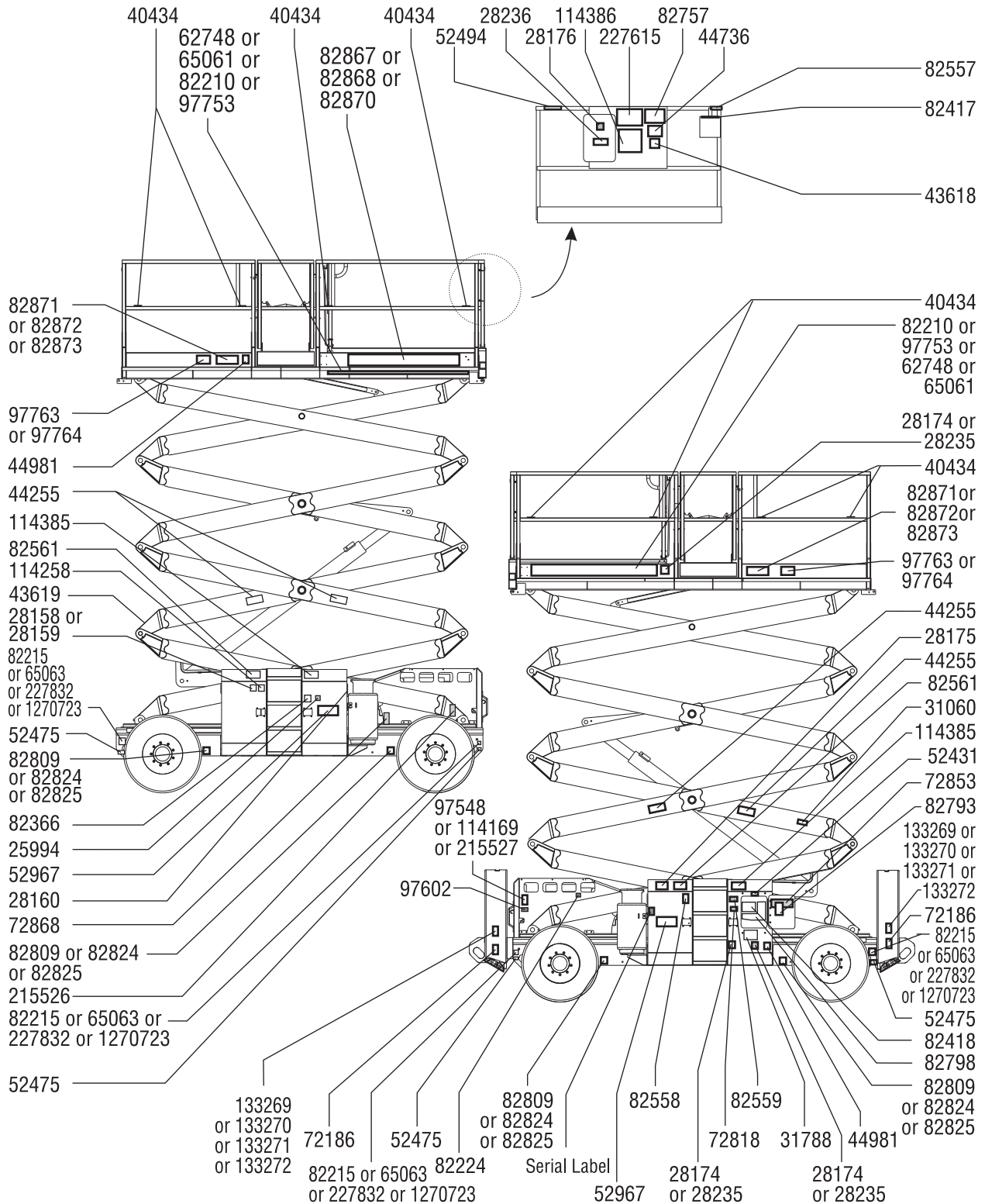

## Inspections

### Inspection for Decals with Words

Determine whether the decals on your machine have words or symbols. Use the appropriate inspection to verify that all decals are legible and in place.

Decal inspection continued from previous page.

| Part No. | Description   | Quantity |
|----------|---|----------|
| 82871    | Danger - Maximum Capacity, GS-3384 & GS-3390                | 2        |
| 82872    | Label - Maximum Capacity, GS-4390                           | 2        |
| 82874    | Label - Maximum Capacity, GS-5390                           | 2        |
| 97548    | Notice - Deutz Engine Specs, Tier II                        | 1        |
| 97602    | Warning - Explosion, Ether                                  | 1        |
| 97753    | Cosmetic - Genie GS-3390                                    | 1        |
| 97763    | Notice - Max Side Force, 400 N, Australia, GS-3384, GS-3390 | 2        |
| 97763    | Notice - Max Side Force, 400 N, Australia, GS-4390          | 2        |
| 97764    | Notice - Max Side Force, 400, N, Australia, GS-5390         | 2        |
| 114169   | Notice - Ford Eng. Spec                                     | 1        |
| 114258   | Danger - Explosion Hazard                                   | 1        |
| 114385   | Danger - Electrocutation Hazard                             | 2        |
| 114386   | Danger - General Safety Rules                               | 1        |
| 133269   | Label - Outrigger Load, GS-3384                             | 4        |
| 133270   | Label - Outrigger Load, GS-3390                             | 4        |
| 133271   | Label - Outrigger Load, GS-4390                             | 4        |
| 133272   | Label - Outrigger Load, GS-5390                             | 4        |
| 215526   | Label - Belt Routing, Ford MSG                              | 1        |
| 215527   | Instructions - Ford MSG Engine                              | 1        |
| 227615   | Notice - Operating Instructions, Platform                   | 1        |
| 227832   | Notice - Tire Specifications                                | 4        |
| 1270723  | Danger - Tip-over Hazard, Tire Specifications               | 4        |

# Inspections

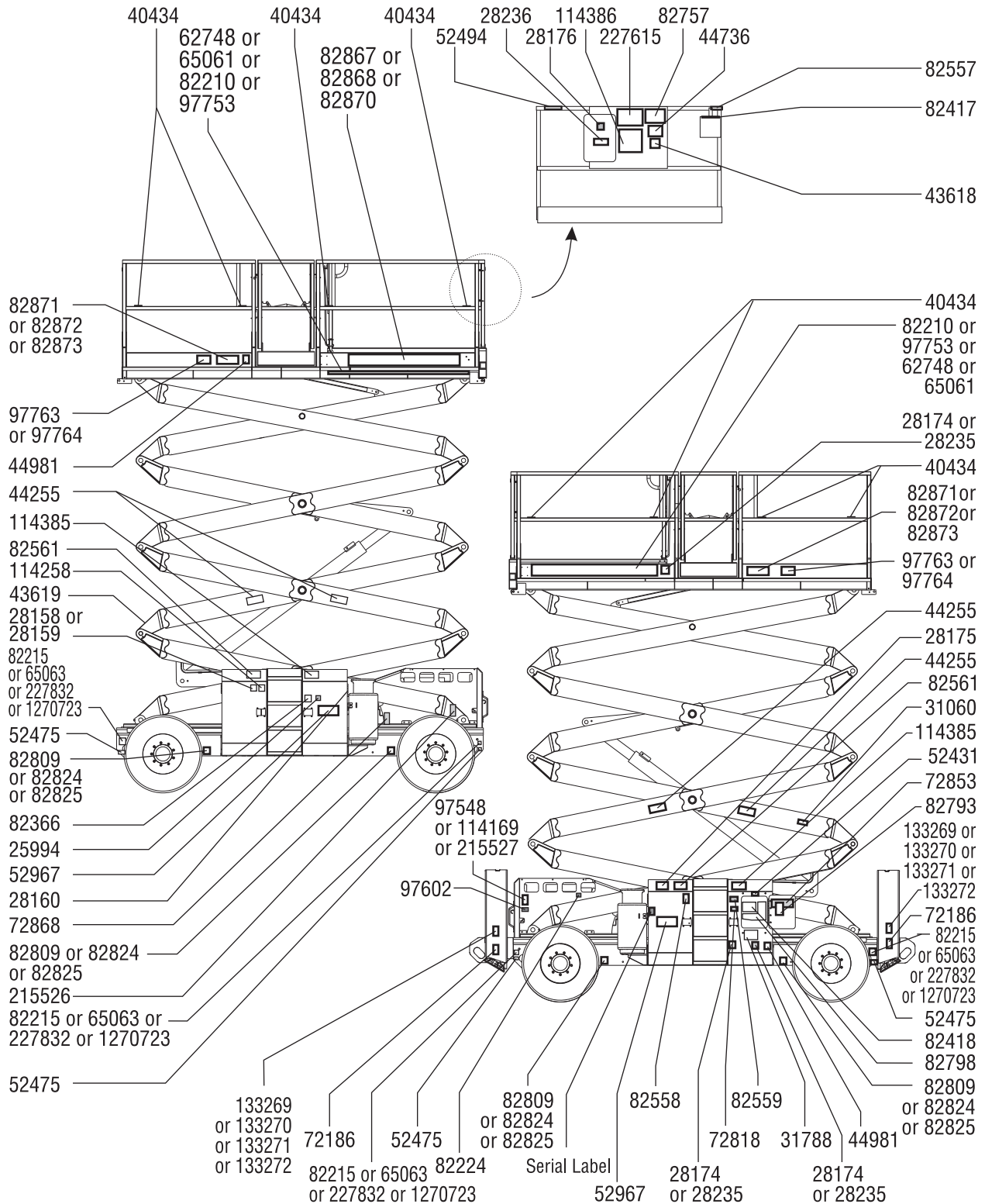

## Operating Instructions



---

### Do Not Operate Unless:

- You learn and practice the principles of safe machine operation contained in this operator's manual.
  - 1 Avoid hazardous situations.
  - 2 Always perform a pre-operation inspection.
  - 3 Always perform function tests prior to use.
  - 4 Inspect the workplace.
  - 5 Only use the machine as it was intended.**

### Fundamentals

The Operating Instructions section provides instructions for each aspect of machine operation. It is the operator's responsibility to follow all the safety rules and instructions in the operator's, safety and responsibilities manuals.

Using the machine for anything other than lifting personnel, along with their tools and materials, to an aerial work site is unsafe and dangerous.

Only trained and authorized personnel should be permitted to operate a machine. If more than one operator is expected to use a machine at different times in the same work shift, they must all be qualified operators and are all expected to follow all safety rules and instructions in the operator's, safety and responsibilities manuals. That means every new operator should perform a pre-operation inspection, function tests, and a workplace inspection before using the machine.

## Operating Instructions

### Emergency Stop

Push in the red Emergency Stop button to the off position at the ground controls or the platform controls to stop all machine functions and turn the engine off.

Repair any function that operates when either red Emergency Stop button is pushed in.

### Starting the Engine

- 1 At the ground controls, turn the key switch to the desired position.
- 2 Be sure both ground and platform control red Emergency Stop buttons are pulled out to the on position.

#### Gasoline/LPG models

- 3 If desired, select LPG by pushing the LPG button.
- 4 Push the engine start button.

Note: In cold conditions, 20°F / -6°C and below, the machine should be started on gasoline and warmed for 2 minutes, then switched to LPG. Warm engines can be started on LPG.

#### Diesel models

- 3 Push the engine start button.

Note: In cold conditions, 50°F / 10°C and below, push and hold the glow plug button for 5 to 10 seconds before starting the engine. Limit continuous use of the glow plug button to 20 seconds.

#### All models

If the engine fails to start after 15 seconds of cranking, determine the cause and repair any malfunction. Wait 60 seconds before trying to start again.

In cold conditions, 20°F / -6°C and below, warm the engine for 5 minutes before operating to prevent hydraulic system damage.

In extreme cold conditions, 0°F / -18°C and below, machines should be equipped with optional cold start kits. Attempting to start the engine when temperatures are below 0°F / -18°C may require the use of a booster battery.

### Operation From Ground

- 1 Turn the key switch to ground control.
- 2 Pull out both ground and platform red Emergency Stop buttons to the on position.
- 3 Start the engine.

#### To Position Platform

- 1 Push and hold the lift function enable button.
- 2 Activate the up function or the down function.

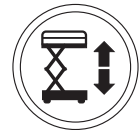

Drive and steer functions are not available from the ground controls.

## Operating Instructions

### Engine Idle Select

Select the engine idle (rpm) by pressing the idle select button. There are three settings for engine idle.



- Indicator light off: low idle
- Indicator light blinking: high idle activated by any function enable button
- Indicator light on: high idle

### Operation From Platform

- 1 Turn the key switch to platform control.
- 2 Pull out the ground and platform red Emergency Stop button to the on position.
- 3 Start the engine.



### To Position Platform

- 1 Push and hold the lift function enable button.
- 2 Activate the up/down rocker switch in the desired direction.

### To Steer

- 1 Press and hold the function enable switch on the control handle.
- 2 Turn the steer wheels with the thumb rocker switch located on the top of the control handle.

### To Drive

- 1 Press and hold the function enable switch on the control handle.
- 2 Increase speed: Slowly move the control handle off center.

Decrease speed: Slowly move the control handle toward center.

Stop: Return the control handle to center or release the function enable switch.

Use the color-coded direction arrows on the platform controls and on the platform to identify the direction the machine will travel.

Machine travel speed is restricted when the platform is raised.

### Drive Select Button



Machine on incline symbol:  
Low range operation for inclines

### Indicator Light On Red



If the indicator light is on red, push in and pull out the red Emergency Stop button to reset the system.

If the light stays red, tag and remove the machine from service.

## Operating Instructions

### Indicator Light Flashing Red



If the indicator light is flashing red, the platform is overloaded and no functions will operate. An alarm will sound at the platform controls.

Remove weight from the platform.

Push in and pull out the red Emergency Stop button to reset the system.

If the platform is still overloaded, the light will continue to flash.

### Driving on a slope

Determine the slope and side slope ratings for the machine and determine the slope grade.



| Maximum slope rating, stowed position |           |
|---------------------------------------|-----------|
| GS-3384, GS-3390, GS-4390             | 50% (26°) |
| GS-5390                               | 40% (22°) |



| Maximum side slope rating, stowed position |           |
|--|-----------|
| GS-3384, GS-3390, GS-4390                  | 50% (26°) |
| GS-5390                                    | 40% (22°) |

Note: Slope rating is subject to ground conditions and adequate traction.

### To determine the slope grade:

Measure the slope with a digital inclinometer OR use the following procedure.

You will need:

- carpenter's level
- straight piece of wood, at least 1 m long
- tape measure

Lay the piece of wood on the slope.

At the downhill end, lay the level on the top edge of the piece of wood and lift the end until the piece of wood is level.

While holding the piece of wood level, measure the distance from the bottom of the piece of wood to the ground.

Divide the tape measure distance (rise) by the length of the piece of wood (run) and multiply by 100.

Example:

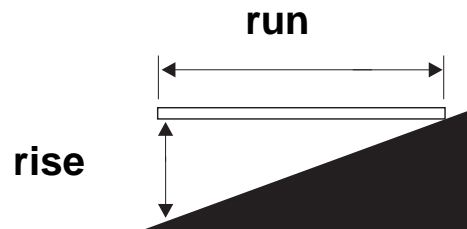

Run = 3.6 m

Rise = 0.3 m

$$0.3 \text{ m} \div 3.6 \text{ m} = 0.083 \times 100 = 8.3\%$$

If the slope exceeds the maximum slope or side slope rating, then the machine must be winched or transported up or down the slope. See Transport and Lifting section.

## Operating Instructions

### To Extend and Retract Platform

- 1 Lift the platform extension lock handle to the horizontal position.
- 2 Push the platform extension lock handle to extend the platform to the desired position.

Do not stand on the platform extension while trying to extend it.

- 3 Lower the platform extension lock handle.

### Emergency Lowering

#### At the Ground Controls

Push and hold the lift function enable button and activate the down function.

In the event of a power failure, use the emergency lowering function.



#### At the Platform Controls

Push and hold the lift function enable button and activate the up/down rocker switch in the down direction.

### Operation From Ground with Controller

Maintain safe distances between the operator, the machine and fixed objects.

Be aware of the direction the machine will travel when using the controller.

### Outrigger Operation (if equipped)

- 1 Position the machine below the desired work area.

Note: The engine must be running for the outriggers to operate.

- 2 Push and hold the auto level button. 
- 3 Activate the up/down rocker switch in the down direction. The outriggers will extend and level the machine. A beep will sound when the machine is level.

The indicator light on the lift function enable button will turn red when one but not all outriggers are down. All drive and lift functions are disabled. 

The light turns green on the lift function enable button and on the individual outrigger buttons when all the outriggers are in firm contact with the ground.

The drive function is disabled while the outriggers are down.

#### To control individual outriggers

- 1 Push and hold one or more outrigger buttons.
- 2 Activate the outrigger up/down rocker switch in the desired direction to level the machine.



## Operating Instructions

### After Each Use

- 1 Select a safe parking location—firm level surface, clear of obstructions and traffic.
- 2 Lower the platform.
- 3 Turn the key switch to the off position and remove the key to secure from unauthorized use.
- 4 Chock the wheels.

## Transport and Lifting Instructions



### Observe and Obey:

- ☑ Genie Industries provides this securement information as a recommendation. Drivers are solely responsible for making sure machines are properly secured and the correct trailer is selected pursuant to US Department of Transportation regulations, other localized regulations, and their company policy.
- ☑ Genie customers needing to containerize any lift or Genie product should source a qualified freight forwarder with expertise in preparing, loading and securing construction and lifting equipment for international shipment.
- ☑ Only qualified aerial lift operators should move the machine on or off the truck.
- ☑ The transport vehicle must be parked on a level surface.
- ☑ The transport vehicle must be secured to prevent rolling while the machine is being loaded.
- ☑ Be sure the vehicle capacity, loading surfaces and chains or straps are sufficient to withstand the machine weight. Genie lifts are very heavy relative to their size. See the serial plate for the machine weight. See the Decals section for the serial label location.
- ☑ If the slope of the transport vehicle bed exceeds the uphill or downhill maximum slope rating, the machine must be loaded and unloaded using a winch as described. See the Specifications section for the slope ratings.

### Free-wheel Configuration for Winching

Chock the wheels to prevent the machine from rolling.

2WD models: Release the non-steer wheel brakes by turning over the torque hub disconnect caps (see below).

4WD models: Release the wheel brakes by turning over all four torque hub disconnect caps (see below).

Be sure the winch line is properly secured to the drive chassis tie points and the path is clear of all obstructions.

Reverse the procedures described to re-engage the brakes.

Note: The pump free-wheel valve should always remain closed.

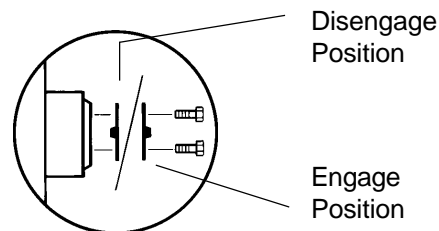

## Transport and Lifting Instructions

### Securing to Truck or Trailer for Transit

Always chock the machine wheels in preparation for transport.

Retract and secure the extension deck(s).

Use the tie-down points on the chassis for anchoring down to the transport surface.

Use a minimum of four chains or straps.

Use chains or straps of ample load capacity.

Turn the key switch to the off position and remove the key before transporting.

Inspect the entire machine for loose or unsecured items.

If the railings have been folded down, secure them with straps before transporting.

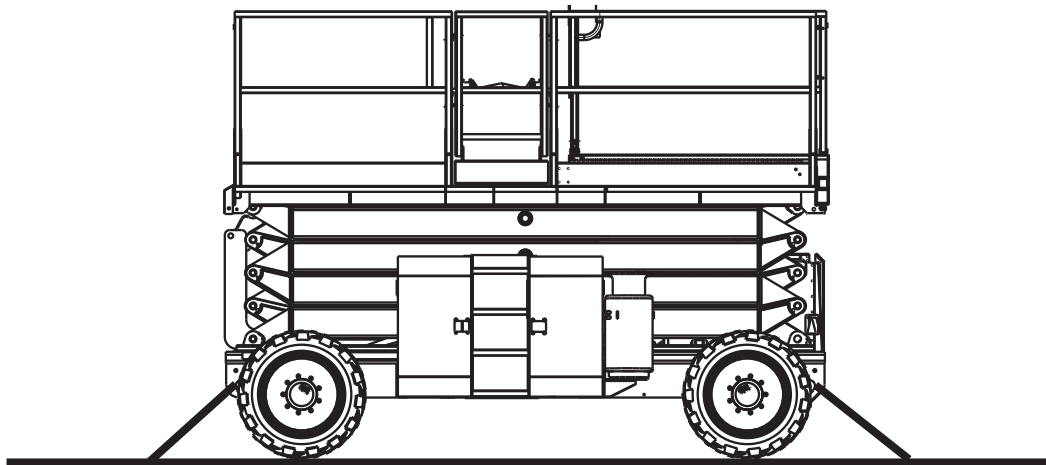
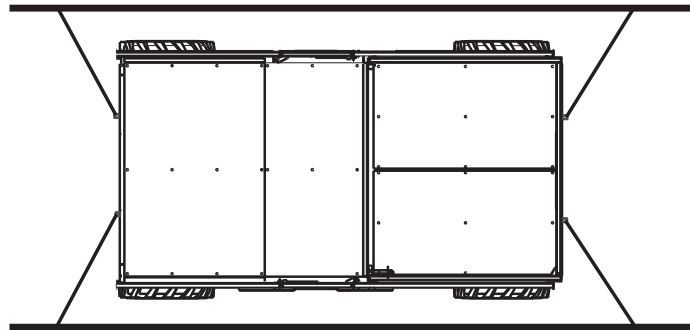

**Genie**  
A TEREX COMPANY

## Transport and Lifting Instructions



### Observe and Obey:

- Only qualified riggers should rig and lift the machine.
- Be sure the crane capacity, loading surfaces and straps or lines are sufficient to withstand the machine weight. See the serial label for the machine weight.

| Center of gravity                    | X Axis | Y Axis  |
|--------------------------------------|--------|---------|
| <b>GS-3384</b><br>without outriggers | 1.8 m  | 97.0 cm |
| <b>GS-3384</b><br>with outriggers    | 1.9 m  | 94.5 cm |
| <b>GS-3390</b><br>without outriggers | 1.8 m  | 97.0 cm |
| <b>GS-3390</b><br>with outriggers    | 1.9 m  | 94.5 cm |
| <b>GS-4390</b><br>without outriggers | 1.8 m  | 1.0 m   |
| <b>GS-4390</b><br>with outriggers    | 1.9 m  | 1.0 m   |
| <b>GS-5390</b>                       | 1.9 m  | 1.0 m   |

### Lifting Instructions

Fully lower the platform. Be sure the extension deck, controls and covers are secure. Remove all loose items on the machine.

Determine the center of gravity of your machine using the table and the picture on this page.

Attach the rigging only to the designated lifting points on the machine.

Adjust the rigging to prevent damage to the machine and to keep the machine level.

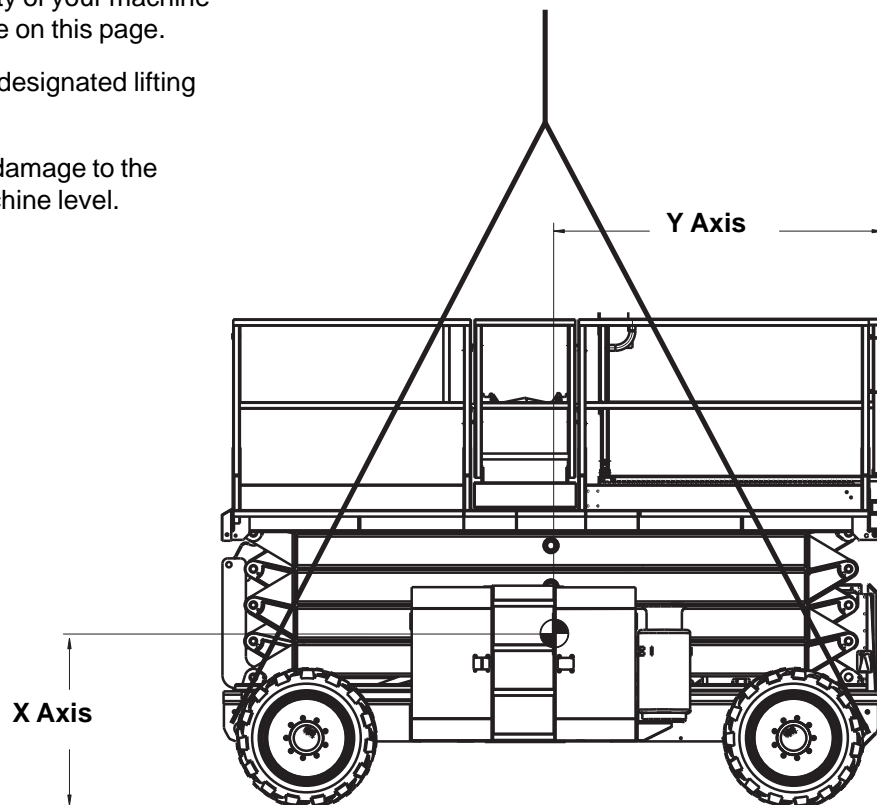

## Maintenance



### Observe and Obey:

- ☑ Only routine maintenance items specified in this manual shall be performed by the operator.
- ☑ Scheduled maintenance inspections shall be completed by qualified service technicians, according to the manufacturer's specifications and the requirements specified in the responsibilities manual.

### Maintenance Symbols Legend

The following symbols have been used in this manual to help communicate the intent of the instructions. When one or more of the symbols appear at the beginning of a maintenance procedure, it conveys the meaning below.



Indicates that tools will be required to perform this procedure.



Indicates that new parts will be required to perform this procedure.



Indicates that a cold engine is required before performing this procedure.

### Check the Batteries



Proper battery condition is essential to good engine performance and operational safety. Improper fluid levels or damaged cables and connections can result in engine component damage and hazardous conditions.

- ⚠ **Electrocution hazard.** Contact with hot or live circuits may result in death or serious injury. Remove all rings, watches and other jewelry.
- ⚠ **Bodily injury hazard.** Batteries contain acid. Avoid spilling or contacting battery acid. Neutralize battery acid spills with baking soda and water.

- 1 Put on protective clothing and eye wear.
- 2 Be sure that the battery cable connections are tight and free of corrosion.
- 3 Be sure that the battery hold-down bars are secure.
- 4 Remove the battery vent caps.
- 5 Check the battery acid level. If needed, replenish with distilled water to the bottom of the battery fill tube. Do not overfill.
- 6 Install the vent caps.

## Maintenance

### Check the Engine Oil Level



Maintaining the proper engine oil level is essential to good engine performance and service life. Operating the machine with an improper oil level can damage engine components.

Note: Check the oil level with the engine off.

- 1 Release the latches on the engine tray and fully slide the engine tray out.
- 2 Insert a 15 cm screwdriver or rod into the engine tray lock hole, located near the engine tray roller wheels, to prevent the engine tray from moving.
- 3 Check the oil level dipstick. Add oil as needed.

---

#### Deutz DL2011L03i Engine

|                            |        |
|----------------------------|--------|
| Oil Type                   | 15W-40 |
| Oil Type - cold conditions | 5W-30  |

---

#### Ford LRG-423 EFI Engine,

|                            |        |
|----------------------------|--------|
| Oil Type                   | 10W-40 |
| Oil Type - cold conditions | 5W-30  |

---

#### Ford MSG-425 Engine

|          |       |
|----------|-------|
| Oil type | 5W-20 |
|----------|-------|

---

### Check the Hydraulic Oil Level



Maintaining the hydraulic oil at the proper level is essential to machine operation. Improper hydraulic oil levels can damage hydraulic components. Daily checks allow the inspector to identify changes in oil level that might indicate the presence of hydraulic system problems.

Note: Perform this procedure with the platform in the stowed position and the engine off.

- 1 Visually inspect the sight gauge located on the side of the hydraulic oil tank.
- ⊙ Result: The hydraulic oil level should be within the top 5 cm of the sight gauge.
- 2 Add oil if necessary. Do not overfill.

---

#### Hydraulic oil specifications

|                    |                             |
|--------------------|-----------------------------|
| Hydraulic oil type | Chevron Rando HD equivalent |
|--------------------|-----------------------------|

---

## Maintenance

### Check the Engine Coolant Level - Ford Models



Maintaining the engine coolant at the proper level is essential to engine service life. Improper coolant level will affect the engine's cooling capability and damage engine components. Daily checks will allow the inspector to identify changes in coolant level that might indicate cooling system problems.

- 1 Check the coolant fluid level. Add fluid as needed.

- ⦿ Result: The fluid level should be visible in the top tank of the radiator.

- ⚠ **Burn Hazard.** Do not remove the radiator cap if the engine and/or radiator is warm. The engine and radiator should be cool to the touch before performing the coolant level inspection.

### Scheduled Maintenance

Maintenance performed quarterly, annually and every two years must be completed by a person trained and qualified to perform maintenance on this machine according to the procedures found in the service manual for this machine.

Machines that have been out of service for more than three months must receive the quarterly inspection before they are put back into service.

## Specifications

| Model   | GS-3384          |
|---|------------------|
| Height, working maximum   | 12.1 m           |
| Height, platform maximum  | 10.1 m           |
| Height, stowed maximum<br>Rails up  | 2.7 m            |
| Height, stowed maximum<br>Rails lowered   | 2.0 m            |
| Width, standard tires   | 2.1 m            |
| Length, platform retracted<br>Models with one extension deck                        | 3.9 m            |
| Length, platform extended<br>Models with one extension deck                         | 5.4 m            |
| Length, platform retracted<br>Models with two extension decks                       | 3.9 m            |
| Length, platform extended<br>Models with two extension decks                        | 6.6 m            |
| Length, platform retracted<br>Models with outriggers<br>Models with two super decks | 4.9 m            |
| Length, platform extended<br>Models with two super decks                            | 7.4 m            |
| Maximum load capacity   | 1134 - 1878 kg   |
| Maximum wind speed  | 12.5 m/s         |
| Wheelbase   | 2.9 m            |
| Turning radius (outside)  | 5.9 m            |
| Turning radius (inside)   | 3.1 m            |
| Ground clearance  | 33 cm            |
| Weight<br>(Machine weights vary with option configurations)                         | See Serial Label |
| Vibration value does not exceed 2.5 m/s <sup>2</sup>                                |                  |
| <b>Airborne noise emissions</b>   |                  |
| Sound pressure level at ground workstation  | 88 dBA           |
| Sound pressure level at platform workstation  | 78 dBA           |
| Guaranteed sound power level  | 107 dBA          |

| <b>Platform dimensions</b>  |                                    |
|---|------------------------------------|
| Platform length x width   | 3.8 x 1.8 m                        |
| Platform extension length   | 1.5 m                              |
| <b>Drive speeds</b>   |                                    |
| Stowed, maximum   | 6.4 km/h                           |
| Platform raised, maximum  | 1.1 km/h<br>12.2 m/39 sec          |
| Controls  | Proportional                       |
| AC outlet in platform   | standard                           |
| Maximum hydraulic pressure<br>(functions)                                 | 241.3 bar                          |
| Tire size - standard tires  | 10-16.5 NHS                        |
| <b>Maximum slope rating,<br/>stowed position</b>                          | 50% (26°)                          |
| <b>Maximum side slope rating,<br/>stowed position</b>                     | 50% (26°)                          |
| Note: Slope rating is subject to ground conditions and adequate traction. |                                    |
| <b>Floor loading information</b>  |                                    |
| Tire load, maximum  | 2161 kg                            |
| Outrigger load, maximum (if equipped)                                     | 2059 kg                            |
| Tire contact pressure   | 8.91 kg/cm <sup>2</sup><br>873 kPa |
| Occupied floor pressure   | 783 kg/m <sup>2</sup><br>7.68 kPa  |

Note: Floor loading information is approximate and does not incorporate different option configurations. It should be used only with adequate safety factors.

Continuous improvement of our products is a Genie policy. Product specifications are subject to change without notice or obligation.





## Specifications

| Model   | GS-3390   |
|---|---|
| Height, working maximum   | 12.1 m  |
| Height, platform maximum  | 10.1 m  |
| Height, stowed maximum<br>Rails up  | 2.7 m   |
| Height, stowed maximum<br>Rails lowered   | 2.0 m   |
| Width, 315/55D20 tires  | 234 cm  |
| Width, 12-33 tires  | 229 cm  |
| Length, platform retracted<br>Models with one extension deck                        | 3.9 m   |
| Length, platform extended<br>Models with one extension deck                         | 5.4 m   |
| Length, platform retracted<br>Models with two extension decks                       | 3.9 m   |
| Length, platform extended<br>Models with two extension decks                        | 6.6 m   |
| Length, platform retracted<br>Models with outriggers<br>Models with two super decks | 4.9 m   |
| Length, platform extended<br>Models with two super decks                            | 7.4 m   |
| Maximum load capacity   | 1134 - 1878 kg  |
| Maximum wind speed  | 12.5 m/s  |
| Wheelbase   | 2.9 m   |
| Turning radius (outside)  | 5.3 m   |
| Turning radius (inside)   | 2.2 m   |
| Ground clearance  | 36 cm   |
| Weight  | See Serial Label<br>(Machine weights vary with option configurations) |
| Vibration value does not exceed 2.5 m/s <sup>2</sup>                                |   |
| <b>Airborne noise emissions</b>   |   |
| Sound pressure level at ground workstation  | 88 dBA  |
| Sound pressure level at platform workstation  | 78 dBA  |
| Guaranteed sound power level  | 107 dBA   |

| <b>Platform dimensions</b>  |                                    |
|---|------------------------------------|
| Platform length x width   | 3.8 x 1.8 m                        |
| Platform extension length   | 1.5 m                              |
| <b>Drive speeds</b>   |                                    |
| Stowed, maximum   | 6.4 km/h                           |
| Platform raised, maximum  | 1.1 km/h<br>12.2 m/39 sec          |
| Controls  | Proportional                       |
| AC outlet in platform   | standard                           |
| Maximum hydraulic pressure<br>(functions)                                 | 241.3 bar                          |
| Tire size - standard tires  | 12 x 21.5                          |
| <b>Maximum slope rating,<br/>stowed position</b>                          | 50% (26°)                          |
| <b>Maximum side slope rating,<br/>stowed position</b>                     | 50% (26°)                          |
| Note: Slope rating is subject to ground conditions and adequate traction. |                                    |
| <b>Floor loading information</b>  |                                    |
| Tire load, maximum  | 2171 kg                            |
| Outrigger load, maximum (if equipped)                                     | 2068 kg                            |
| Tire contact pressure   | 8.80 kg/cm <sup>2</sup><br>862 kPa |
| Occupied floor pressure   | 735 kg/m <sup>2</sup><br>7.21 kPa  |

Note: Floor loading information is approximate and does not incorporate different option configurations. It should be used only with adequate safety factors.

Continuous improvement of our products is a Genie policy. Product specifications are subject to change without notice or obligation.



## Specifications

| Model   | GS-4390          |
|---|------------------|
| Height, working maximum   | 15.1 m           |
| Height, platform maximum  | 13.1 m           |
| Height, stowed maximum<br>Rails up  | 2.9 m            |
| Height, stowed maximum<br>Rails lowered   | 2.3 m            |
| Width, 315/55D20 tires  | 234 cm           |
| Width, 12-33 tires  | 229 cm           |
| Width, high-flotation tires   | 257 cm           |
| Length, platform retracted<br>Models with one extension deck                        | 3.9 m            |
| Length, platform extended<br>Models with one extension deck                         | 5.4 m            |
| Length, platform retracted<br>Models with two extension decks                       | 3.9 m            |
| Length, platform extended<br>Models with two extension decks                        | 6.6 m            |
| Length, platform retracted<br>Models with outriggers<br>Models with two super decks | 4.9 m            |
| Length, platform extended<br>Models with two super decks                            | 7.4 m            |
| Maximum load capacity   | 680 - 1286 kg    |
| Maximum wind speed  | 12.5 m/s         |
| Wheelbase   | 2.9 m            |
| Turning radius (outside)  | 5.3 m            |
| Turning radius (inside)   | 2.2 m            |
| Ground clearance  | 36 cm            |
| Weight<br>(Machine weights vary with option configurations)                         | See Serial Label |
| Vibration value does not exceed 2.5 m/s <sup>2</sup>                                |                  |
| <b>Airborne noise emissions</b>   |                  |
| Sound pressure level at ground workstation  | 88 dBA           |
| Sound pressure level at platform workstation  | 78 dBA           |
| Guaranteed sound power level  | 107 dBA          |

| <b>Platform dimensions</b>  |                                    |
|---|------------------------------------|
| Platform length x width   | 3.8 x 1.8 m                        |
| Platform extension length   | 1.5 m                              |
| <b>Drive speeds</b>   |                                    |
| Stowed, maximum   | 6.4 km/h                           |
| Platform raised, maximum  | 1.1 km/h<br>12.2 m/39 sec          |
| Controls  | Proportional                       |
| AC outlet in platform   | standard                           |
| Maximum hydraulic pressure<br>(functions)                                 | 241.3 bar                          |
| Tire size - standard tires  | 12 x 21.5                          |
| <b>Maximum slope rating,<br/>stowed position</b>                          | 50% (26°)                          |
| <b>Maximum side slope rating,<br/>stowed position</b>                     | 50% (26°)                          |
| Note: Slope rating is subject to ground conditions and adequate traction. |                                    |
| <b>Floor loading information</b>  |                                    |
| Tire load, maximum  | 2237 kg                            |
| Outrigger load, maximum (if equipped)                                     | 2126 kg                            |
| Tire contact pressure   | 8.80 kg/cm <sup>2</sup><br>862 kPa |
| Occupied floor pressure   | 735 kg/m <sup>2</sup><br>7.21 kPa  |

Note: Floor loading information is approximate and does not incorporate different option configurations. It should be used only with adequate safety factors.

Continuous improvement of our products is a Genie policy. Product specifications are subject to change without notice or obligation.



## Specifications

| Model   | GS-5390          |
|---|------------------|
| Height, working maximum   | 18.2 m           |
| Height, platform maximum  | 16.2 m           |
| Height, stowed maximum<br>Rails up  | 3.2 m            |
| Height, stowed maximum<br>Rails lowered   | 2.5 m            |
| Width, 315/55D20 tires  | 234 cm           |
| Width, 12-33 tires  | 229 cm           |
| Width, high-flotation tires   | 257 cm           |
| Length, platform retracted<br>Models with one extension deck                        | 4.9 m            |
| Length, platform extended<br>Models with one extension deck                         | 5.4 m            |
| Length, platform retracted<br>Models with two extension decks                       | 4.9 m            |
| Length, platform extended<br>Models with two extension decks                        | 6.6 m            |
| Length, platform retracted<br>Models with outriggers<br>Models with two super decks | 4.9 m            |
| Length, platform extended<br>Models with two super decks                            | 7.4 m            |
| Maximum load capacity   | 680 - 1410 kg    |
| Maximum wind speed  | 12.5 m/s         |
| Wheelbase   | 2.9 m            |
| Turning radius (outside)  | 5.3 m            |
| Turning radius (inside)   | 2.2 m            |
| Ground clearance  | 36 cm            |
| Weight<br>(Machine weights vary with option configurations)                         | See Serial Label |
| Vibration value does not exceed 2.5 m/s <sup>2</sup>                                |                  |
| <b>Airborne noise emissions</b>   |                  |
| Sound pressure level at ground workstation  | 88 dBA           |
| Sound pressure level at platform workstation  | 78 dBA           |
| Guaranteed sound power level  | 107 dBA          |

| Platform dimensions   |                                    |
|---|------------------------------------|
| Platform length x width   | 3.8 x 1.8 m                        |
| Platform extension length   | 1.5 m                              |
| <b>Drive speeds</b>   |                                    |
| Stowed, maximum   | 6.4 km/h                           |
| Platform raised, maximum  | 1.1 km/h<br>12.2 m/39 sec          |
| Controls  | Proportional                       |
| AC outlet in platform   | standard                           |
| Maximum hydraulic pressure<br>(functions)                                 | 241.3 bar                          |
| Tire size - standard tires  | 12 x 21.5                          |
| <b>Maximum slope rating,<br/>stowed position</b>                          | 40% (22°)                          |
| <b>Maximum side slope rating,<br/>stowed position</b>                     | 40% (22°)                          |
| Note: Slope rating is subject to ground conditions and adequate traction. |                                    |
| <b>Floor loading information</b>  |                                    |
| Tire load, maximum  | 2426 kg                            |
| Outrigger load, maximum   | 2426 kg                            |
| Tire contact pressure   | 9.18 kg/cm <sup>2</sup><br>900 kPa |
| Occupied floor pressure   | 922 kg/m <sup>2</sup><br>9.04 kPa  |

Note: Floor loading information is approximate and does not incorporate different option configurations. It should be used only with adequate safety factors.

Continuous improvement of our products is a Genie policy. Product specifications are subject to change without notice or obligation.



Distributed By: